

Surname						Other Names					
Centre Number						Candidate Number					
Candidate Signature											

For Examiner's Use

General Certificate of Secondary Education
November 2008



MATHEMATICS (SPECIFICATION A)
Higher Tier
Paper 1 Non-calculator

4301/1H
H

Thursday 6 November 2008 9.00 am to 11.00 am

<p>For this paper you must have:</p> <ul style="list-style-type: none"> mathematical instruments. <p>You must not use a calculator.</p>	
--	--

For Examiner's Use	
Pages	Mark
3	
4–5	
6–7	
8–9	
10–11	
12–13	
14–15	
16–17	
18–19	
20–21	
22–23	
TOTAL	
Examiner's Initials	

Time allowed: 2 hours

Instructions

- Use black ink or black ball-point pen. Draw diagrams in pencil.
- Fill in the boxes at the top of this page.
- Answer **all** questions.
- You must answer the questions in the spaces provided. Answers written in margins or on blank pages will not be marked.
- Do all rough work in this book.

Information

- The maximum mark for this paper is 100.
- The marks for questions are shown in brackets.
- You may ask for more answer paper, graph paper and tracing paper. This must be tagged securely to this answer booklet.

Advice

- In all calculations, show clearly how you work out your answer.



Formulae Sheet: Higher Tier

Area of trapezium = $\frac{1}{2}(a+b)h$

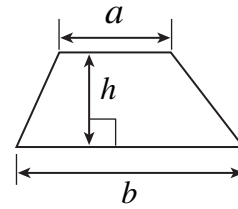

Volume of prism = area of cross-section \times length

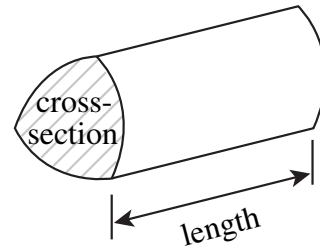

Volume of sphere = $\frac{4}{3}\pi r^3$

Surface area of sphere = $4\pi r^2$

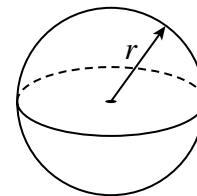

Volume of cone = $\frac{1}{3}\pi r^2 h$

Curved surface area of cone = $\pi r l$

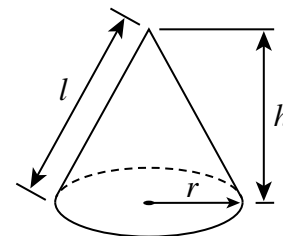

In any triangle ABC

Area of triangle = $\frac{1}{2}ab \sin C$

Sine rule $\frac{a}{\sin A} = \frac{b}{\sin B} = \frac{c}{\sin C}$

Cosine rule $a^2 = b^2 + c^2 - 2bc \cos A$

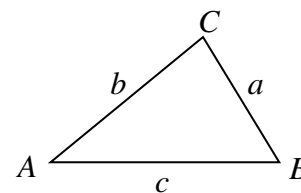

The Quadratic Equation

The solutions of $ax^2 + bx + c = 0$, where $a \neq 0$, are given by

$$x = \frac{-b \pm \sqrt{(b^2 - 4ac)}}{2a}$$



Answer **all** questions in the spaces provided.

1 Estimate the value of $\frac{(87.6 + 31.1)}{5.08 \times 7.93}$

.....
.....
.....

Answer (3 marks)

2 A two-stage operation is shown.

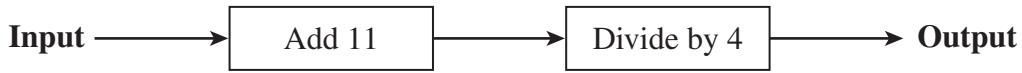

2 (a) When the input is -3, what is the output?

.....
.....

Answer (1 mark)

2 (b) When the input is *n*, what is the output?

.....
.....

Answer (2 marks)

3 Andy's salary is £24 000 per year.
He is paid the same amount each month.
He is given a pay rise of 10%.

Calculate his new **monthly** salary.
You **must** show all your working.

.....
.....
.....
.....

Answer £ (4 marks)

Turn over ►



- 4 (a) A class take their Key Stage 3 test in Mathematics.
Design a two-way table to show the results for both Boys and Girls.
The results should cover levels 4 to 7.

(3 marks)

- 4 (b) Invent data for 20 pupils and fill in your two-way table.

(1 mark)



5 In the diagram, AB is parallel to CD .

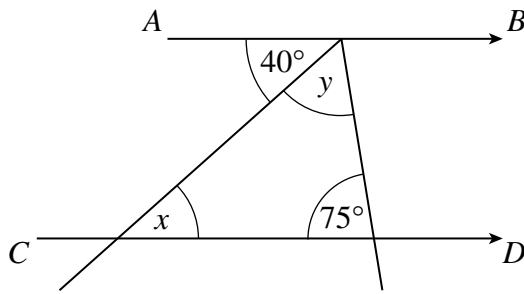

Not drawn accurately

5 (a) Write down the value of x .

.....

Answer degrees (1 mark)

5 (b) Work out the value of y .

.....

.....

Answer degrees (2 marks)

6 A triangle has angles of 80° , x and $4x$.

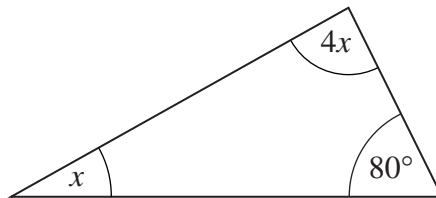

Not drawn accurately

6 (a) Work out the value of x .

.....

.....

Answer degrees (2 marks)

6 (b) What kind of triangle is this?
Give a reason for your answer.

Answer (1 mark)

Reason

.....

(1 mark)



- 7 A helicopter flies from A to B .
The diagram shows the position of A and B .

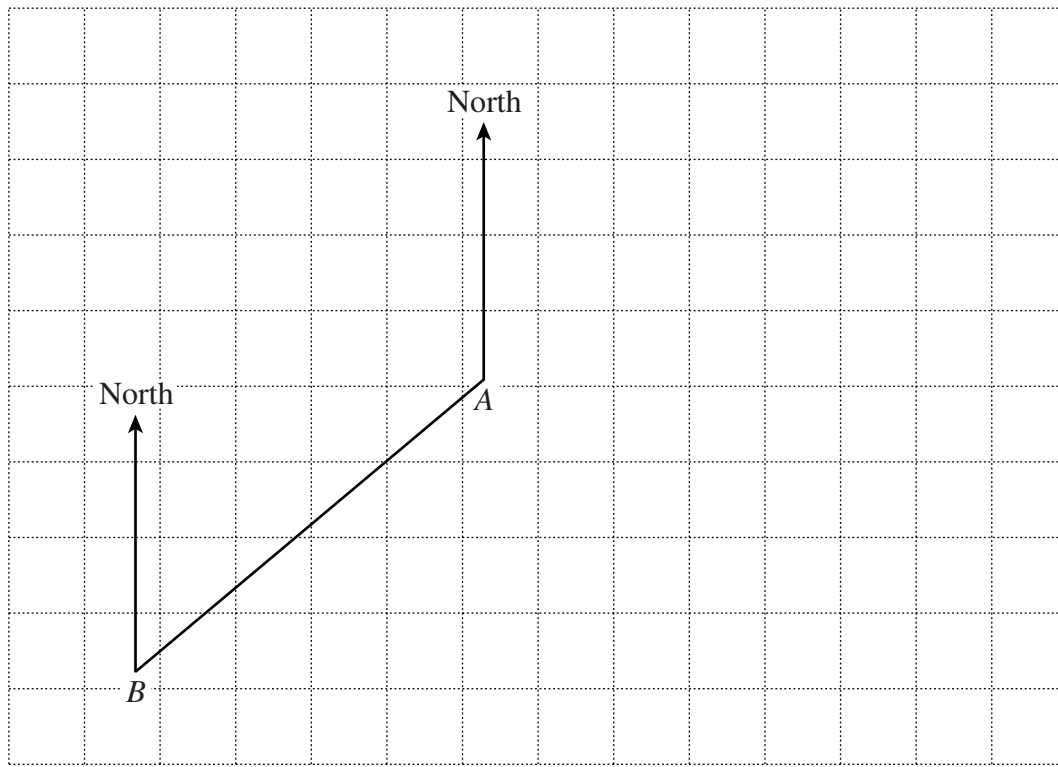

- 7 (a) Measure and write down the three figure bearing of B from A .

Answer $^{\circ}$ (1 mark)

- 7 (b) The helicopter then flies to C .
The bearing of C from A is 110°
The bearing of C from B is 080°

Mark the position of C on the diagram.

(3 marks)



8 Find the n th term of this sequence.

6, 10, 14, 18,

.....
.....

Answer (2 marks)

9 (a) Solve $\frac{18}{w} = 3$

.....

Answer $w =$ (1 mark)

9 (b) Solve $5(x + 4) = 10$

.....
.....
.....

Answer $x =$ (3 marks)

9 (c) Solve $11 + \frac{y}{3} = 15$

.....
.....
.....

Answer $y =$ (2 marks)



10 The table shows the ages of 40 people in a village.

Age, x (years)	Frequency
$0 < x \leq 20$	4
$20 < x \leq 40$	12
$40 < x \leq 60$	16
$60 < x \leq 80$	6
$80 < x \leq 100$	2

10 (a) Write down the modal class for the ages of the people.

Answer $< x \leq$ (1 mark)

10 (b) Draw a frequency polygon to represent the data.

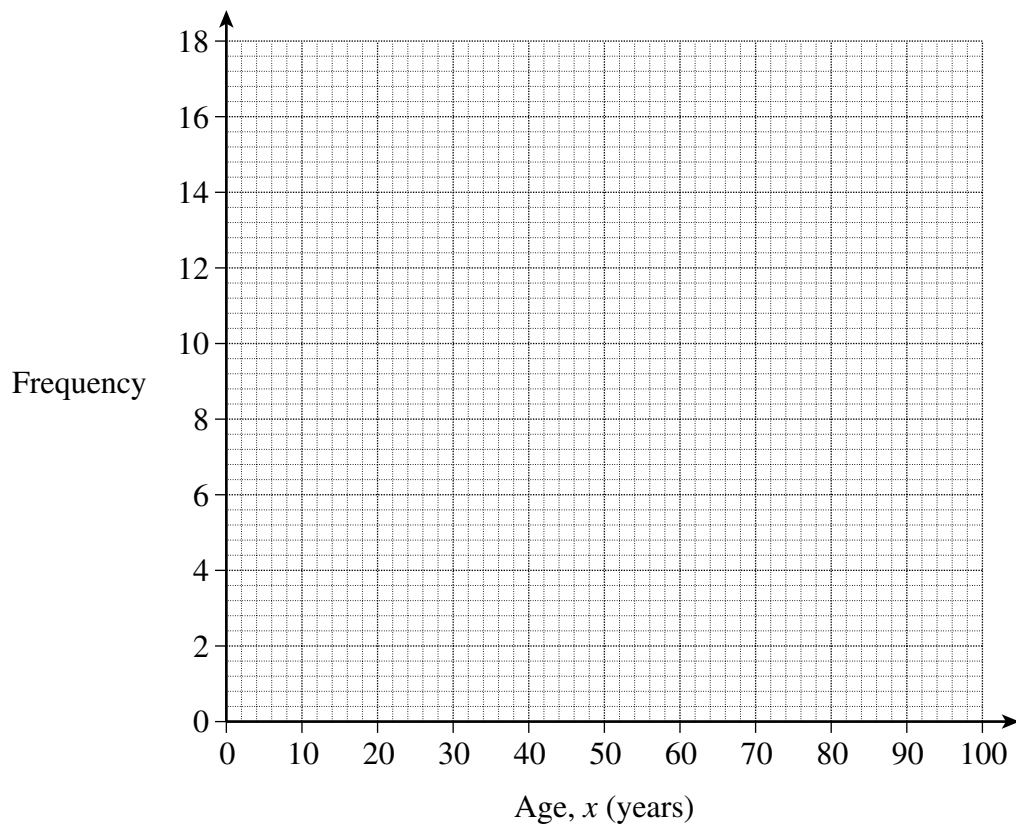

(2 marks)



11 The shaded shape below is cut from a piece of rectangular card measuring 10 cm by 15 cm.

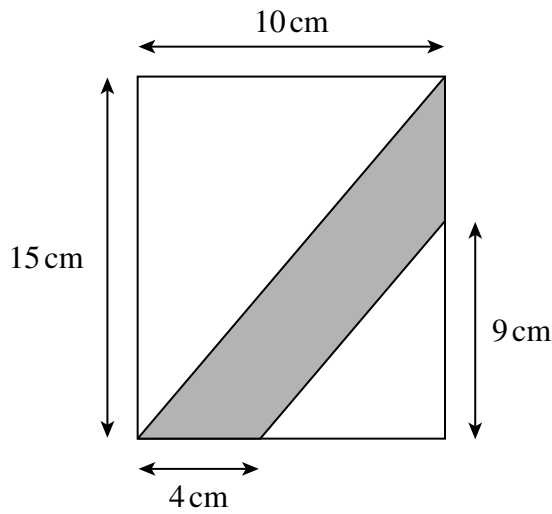

Not drawn accurately

11 (a) The larger right-angled triangle has two sides of 15 cm and 10 cm, as shown. Show that the area of this triangle is 75 cm^2 .

.....

(1 mark)

11 (b) Calculate the area of the shaded shape. State the units of your answer. You **must** show all your working.

.....

.....

.....

.....

.....

.....

.....

Answer (4 marks)



12 (a) Find the Highest Common Factor (HCF) of 8 and 12

.....
.....

Answer (2 marks)

12 (b) Find the Least Common Multiple (LCM) of 8 and 12

.....
.....

Answer (2 marks)

13 For the function $f(x) = 3x^2 - 2$

13 (a) Work out the value of $f(x)$ when $x = 0$

.....
.....

Answer (1 mark)

13 (b) Work out the value of $f(x)$ when $x = 2$

.....
.....

Answer (1 mark)

13 (c) Work out both values of x when $f(x) = 73$

.....
.....
.....
.....

Answer (3 marks)



14 Work out the value of the following.
Give your answers in standard form.

14 (a) $(2.1 \times 10^5) + (7 \times 10^4)$

.....
.....
.....
.....

Answer (2 marks)

14 (b) $(2.1 \times 10^5) \times (7 \times 10^4)$

.....
.....
.....
.....

Answer (2 marks)

Turn over for the next question



- 15** (a) P, Q and R are points on the circumference of a circle, centre O .
 PR is a diameter of the circle.

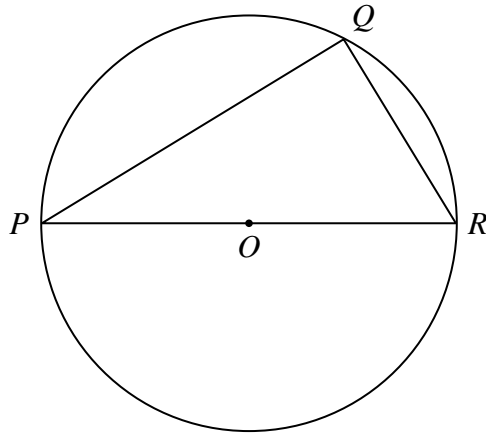

Not drawn accurately

Write down the size of angle PQR .

Answer degrees (1 mark)

- 15** (b) T is also a point on the circumference of the circle in part (a).
 Angle $QTR = 27^\circ$

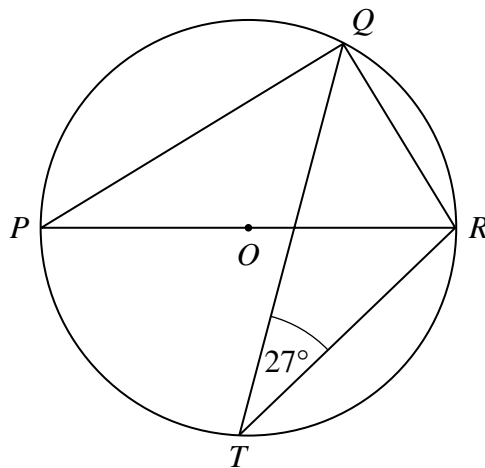

Not drawn accurately

- 15** (b) (i) Write down the size of angle RPQ .

Answer degrees (1 mark)

- 15** (b) (ii) Work out the size of angle PRQ .

.....

Answer degrees (1 mark)



- 15** (c) S is another point on the circumference of the circle in part (a).
 QS is a diameter of the circle.
 Angle $PRS = 38^\circ$

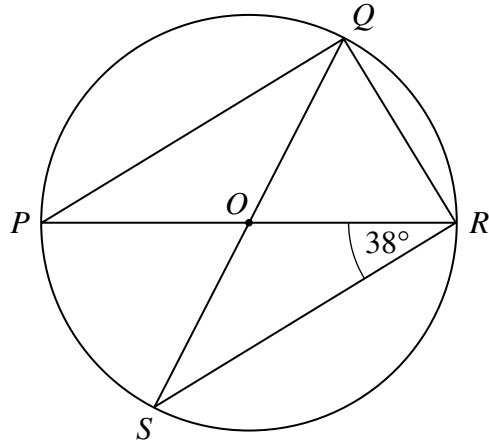

Not drawn accurately

Work out the size of angle SQR .

.....

Answer degrees (1 mark)

Turn over for the next question



16 In this 'magic' triangle each side has a total of 24

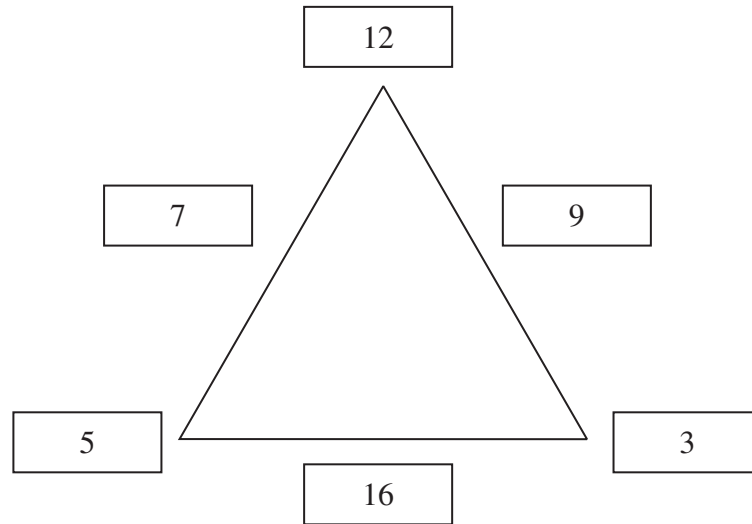

Here is another 'magic' triangle in which the sum of the three expressions on each of the three sides is the same.

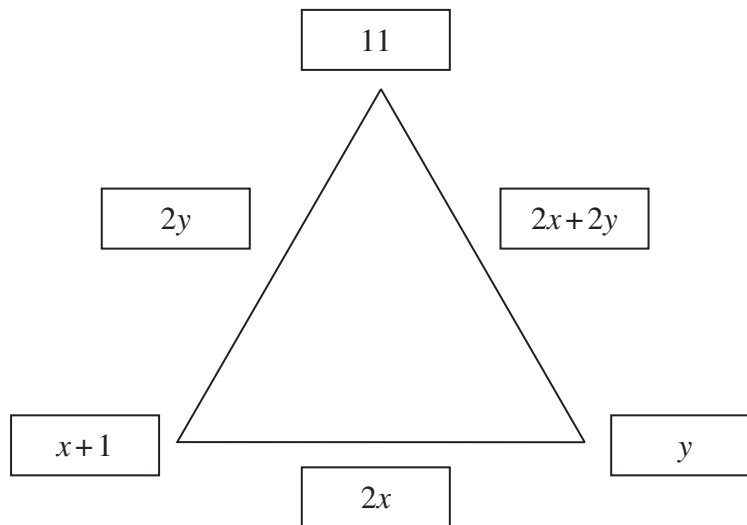

16 (a) By considering the left hand side and the right hand side, show that $x + y = 1$

.....

.....

.....

(2 marks)



16 (b) By considering the left hand side and the bottom of the triangle, show that $2x - y = 11$

.....

Answer (2 marks)

16 (c) Solve the simultaneous equations $x + y = 1$
 $2x - y = 11$

You **must** show your working.

.....

Answer $x =$, $y =$ (2 marks)

16 (d) Complete the 'magic' triangle.

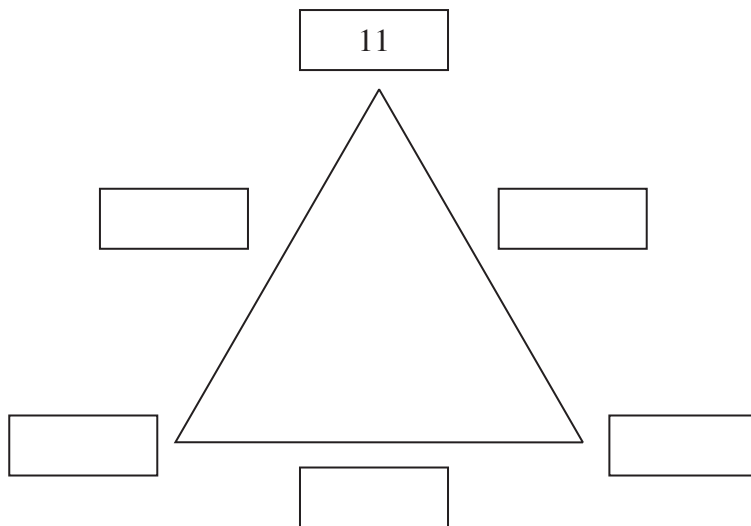

(1 mark)

Turn over ►



17 Show that $8^{\frac{1}{3}} \times 2^{-5} = 4^{-2}$

.....

.....

.....

.....

.....

.....

(3 marks)

18 (a) Factorise $2n^2 + 9n + 9$

.....

.....

.....

.....

Answer (2 marks)

18 (b) Hence, or otherwise, write 299 as the product of two prime factors.

.....

.....

.....

.....

Answer (1 mark)



19 At the end of a training course candidates must take a test in order to pass the course.
The probability of passing the test at the first attempt is 0.8
Those who fail re-sit once.
The probability of passing the re-sit is 0.5
No further attempts are allowed.

19 (a) (i) Complete the tree diagram, which shows all the possible outcomes.

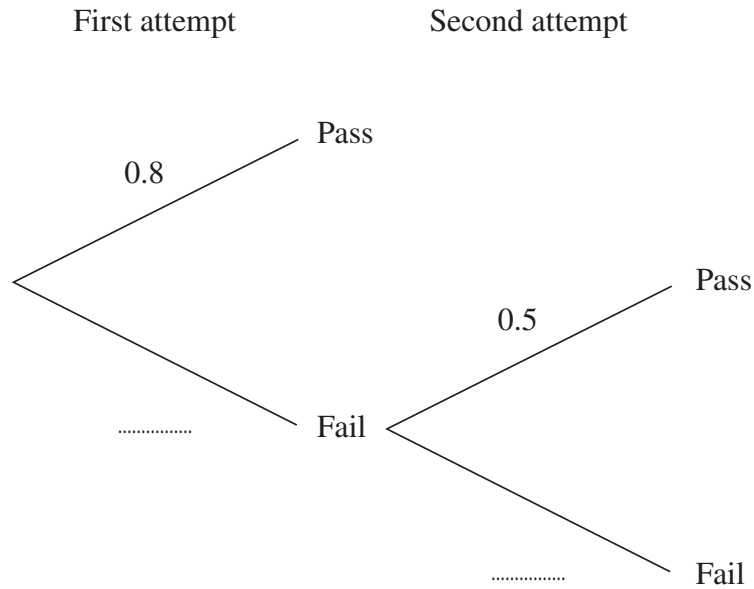

(1 mark)

19 (a) (ii) What is the probability that a candidate fails both attempts and so fails the course?

.....
.....

Answer (2 marks)

19 (b) What is the probability that a candidate passes the course?

.....

Answer (1 mark)

19 (c) Hassan and Louise both take the training course.
What is the probability that one of them passes and one of them fails?

.....
.....
.....
.....

Answer (3 marks)



- 21 The diagram shows a prism.
 The cross-section of the prism is a sector of a circle of radius 12 cm.
 The angle of the sector is 60°
 The prism is 20 cm long.

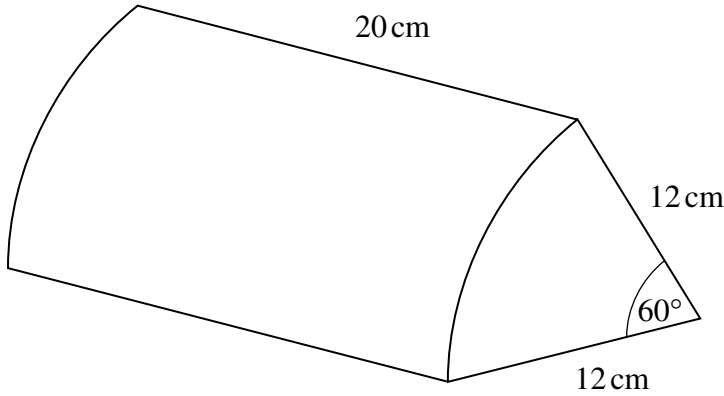

Not drawn accurately

Calculate the volume of the prism.
 Give your answer in terms of π .

.....

.....

.....

.....

.....

.....

Answer cm^3 (4 marks)

- 22 Find the value of x if $\frac{\sqrt{x} \times \sqrt{50}}{\sqrt{5}} = 4\sqrt{5}$

.....

.....

.....

.....

.....

Answer $x =$ (4 marks)



23 This is the graph of $y = \sin x$ for $0^\circ \leq x \leq 360^\circ$

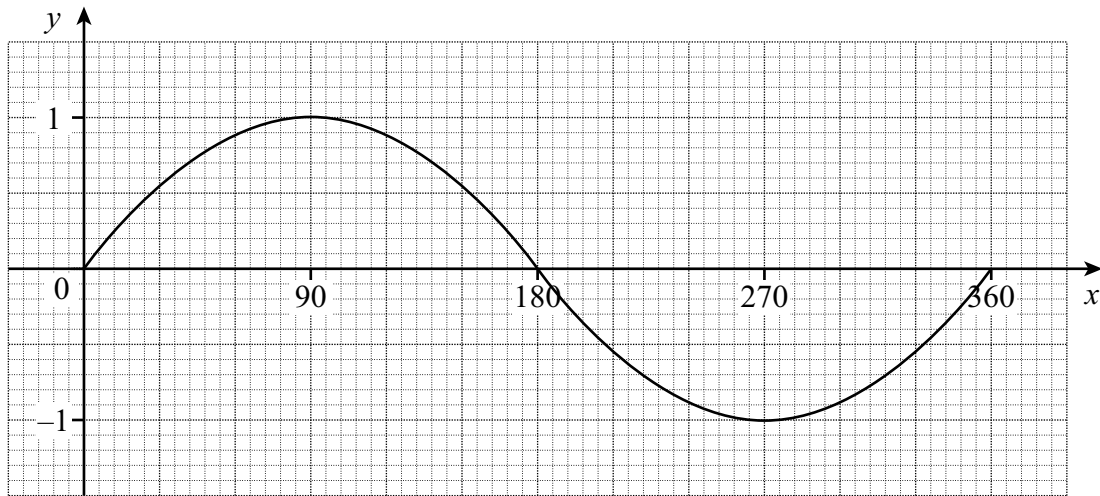

On the axes draw the following graphs for $0^\circ \leq x \leq 360^\circ$
The graph of $y = \sin x$ is shown dotted to help you.

23 (a) $y = \sin(x + 90)$

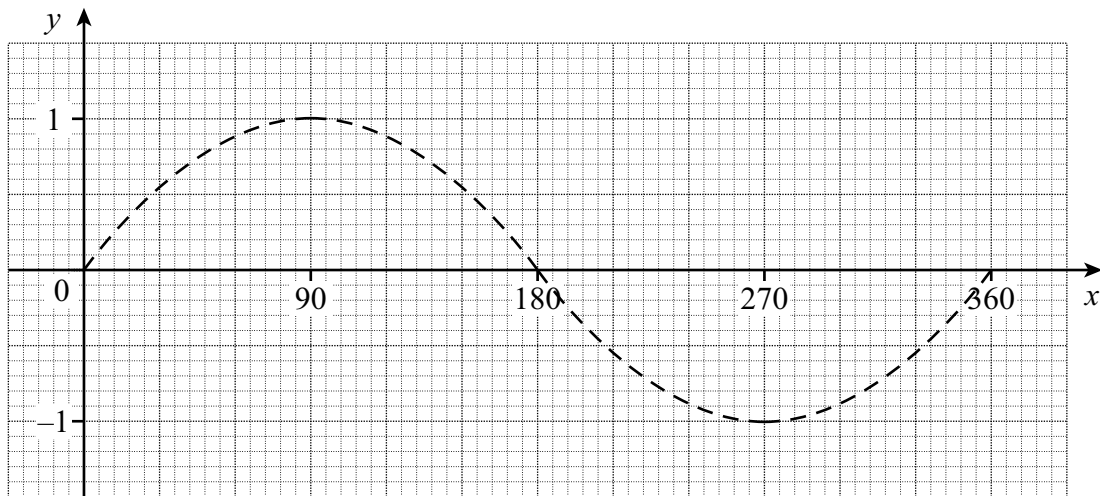

(1 mark)



23 (b) $y = \frac{1}{2} \sin x$

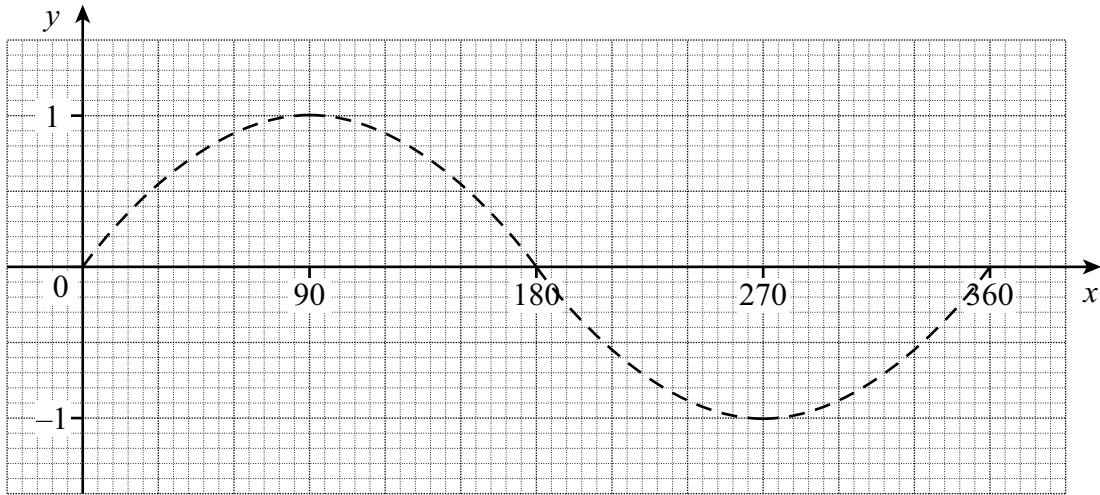

(1 mark)

23 (c) $y = \sin \frac{x}{2}$

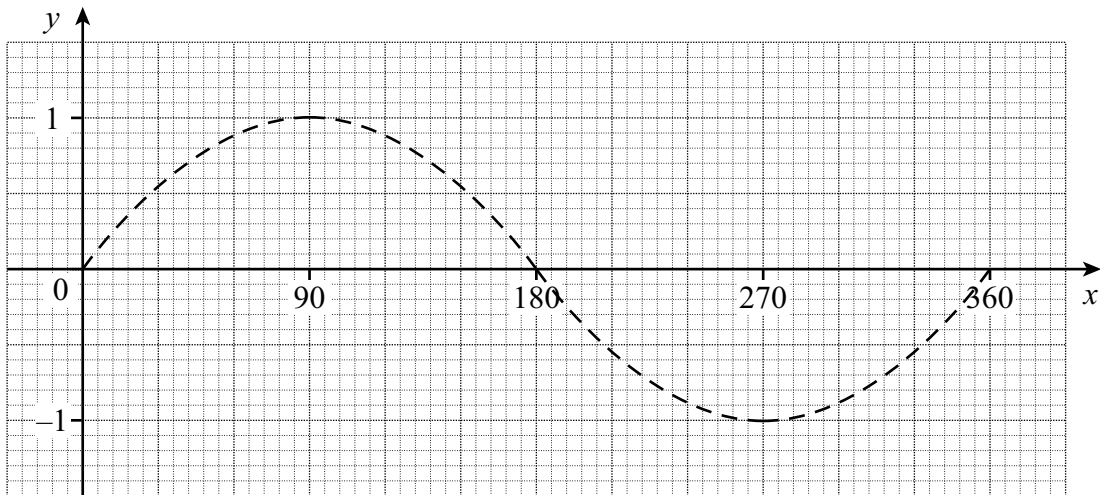

(1 mark)

Turn over ►



24 OAB is a triangle with P the mid-point of OA and M the mid-point of AB .

$\vec{OP} = \mathbf{a}$, $\vec{PA} = \mathbf{a}$ and $\vec{OB} = 2\mathbf{b}$

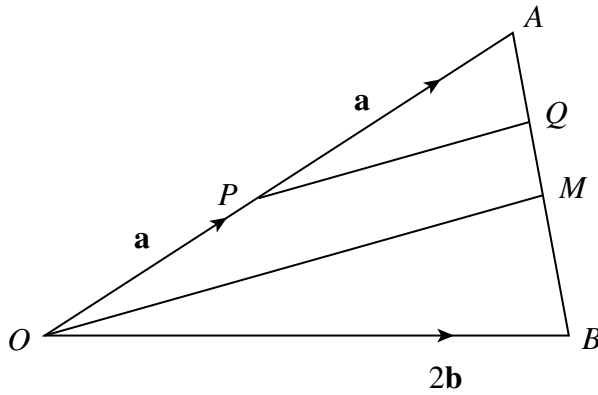

Not drawn accurately

24 (a) Write down an expression for \vec{AB} in terms of \mathbf{a} and \mathbf{b} .

.....

Answer (1 mark)

24 (b) Q lies on AB such that $\vec{AQ} = \frac{1}{4} \vec{AB}$

Show that $\vec{PQ} = \frac{1}{2} \mathbf{a} + \frac{1}{2} \mathbf{b}$

Explain your answer.

.....

Answer (2 marks)



24 (c) Write down, and simplify, an expression for \vec{OM} in terms of **a** and **b**.

.....
.....
.....

Answer (2 marks)

24 (d) Explain why the answers for part (b) and part (c) show that $OPQM$ is a trapezium.

.....
.....

(1 mark)

END OF QUESTIONS



There are no questions printed on this page

**DO NOT WRITE ON THIS PAGE
ANSWER IN THE SPACES PROVIDED**

Copyright © 2008 AQA and its licensors. All rights reserved.

